

2.00 mm. HARD METRIC CONNECTORS

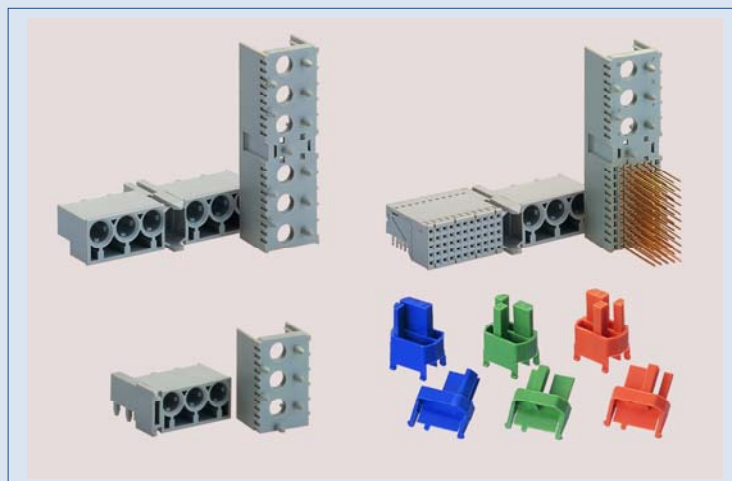

2.00 mm. HARD METRIC CONNECTORS

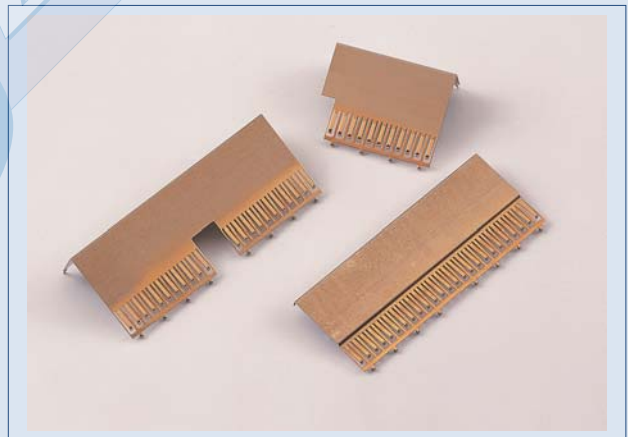
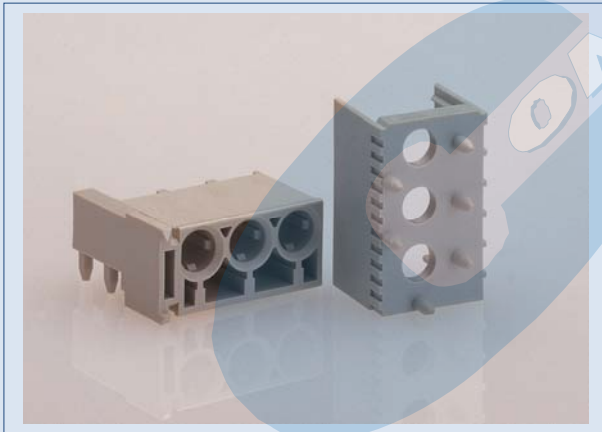

General Specifications.

General Features

- Available in type A, AB25, AB22, AB19, B25, B22, B19, C, L, M and N with full sets of keys
- Upper and lower shielding for the female connector.
- Three different pin length in contact area and four different length in rear mating area for the male connector
- Full series are in press-fit termination
- Inverse mating configuration
- Minimum wiping length: 2,5 mm
- Meet standard coding system(MPC) according to IEC61076-4-101
- Two rows(z and f) of male connectors are for the shielding of female connectors
- Recommended plated through hole 0,60 +-0,05 mm for the press-fitting
- Ideal for digital high speed data applications with excellent parameters for impedance match, propagation delay, cross talk, reflection
- End to end stackable
- Five signal rows plus outer rows for shieldings
- 2.00 mm Hard metric and DIN 41612 connectors can be used on the same PCB as both have the same mating distance
- Coding system prevents mix-up and wrong mating between male and female connectors
- Rear pin options (4 lengths) for through the backplane I/O applications
- High density capability
- Shield for EMI/RFI protection
- Expandability for end user application

Mechanical features

- Grid size: 2,00 mm
- Air and creepage distance: Male 0,80, Female 0,60 mm.
- Contact level: Level 1 (5,30 mm); Level 2 (6,80 mm); Level 3 (8,30 mm)
- Mating force for signal contact: 0,075 Kg f Maximum x contact
- Mating force for shield contact: 0,1 Kg f Max. x contact
- Withdrawal force: 0,015 Kg f Min. per contact
- Termination: Press-fit
- Misalignment: Longitudinal +- 2,00 mm
Latitudinal: +- 2,50 mm
- Inclination: ± 2 degree
- PCB plated through hole
Drilled hole: 0,69 to 0,72 mm diameter
Cu: 25 µ min.
Sn: 5-15 µ min.
- Plated hole: 0,55 to 0,65 mm diameter

Materials

- Insulator: Glass filled Polyester UL 94 V-0
- Contact: Phosphor bronze
- U/L file E149341, Electric rating: 250V, 2A
- Operating temperature. -55°C to + 125°C
- RoHS compliant

Electrical Features

- Current rating: 1,5 A at 20 °C. 1 A at 70° C
- Contact resistance: 0,20 milliohms max.
- Insulation resistance: 104 Megohms min.
- Test voltage: 750 Vrms



2.00 mm. HARD METRIC CONNECTORS



Ordering and part numbers.

Ordering Information:

SERIE- T- XXX- DD- PL- L- S

1 2 3 4 5 6 7

1. Connector Series

2. (T) Contact Plating

- T = 3. Class 3. Gold flash plating
- T = 4. Class 2. 12 μ Pd/Ni + 2 μ Au (Recommended)
- T = 5. Class 1. 25 μ Pd/Ni + 2 μ Au

3. (XXX) Number of circuits

- XXX. Number of circuits (Check your serie)

4. (DD) Contact arrangement

- DD. Differents options available (Check your serie)

5. (PL) Pin Length

- 1A. Dim. 3.70 / 8.20 mm.
*Check Table for all measures Options
- 6C. Dim. 16.00 / 11.20 mm.

6. (L) Locating Pegs

- 0. Without pegs
- 1. With pegs

7. (S) Shielding

- 0. Not shielding
- 1. Shielding (Row Z and F)

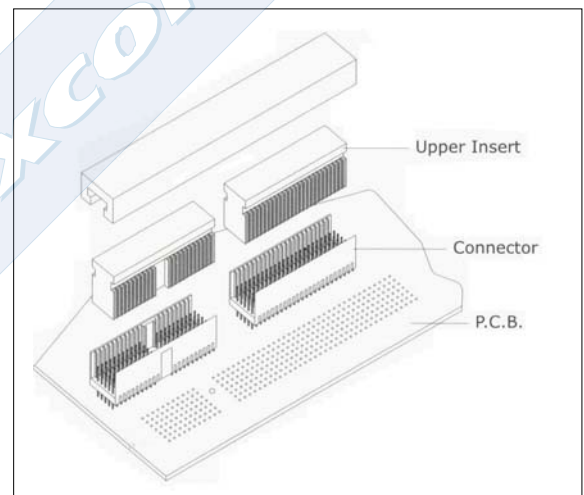
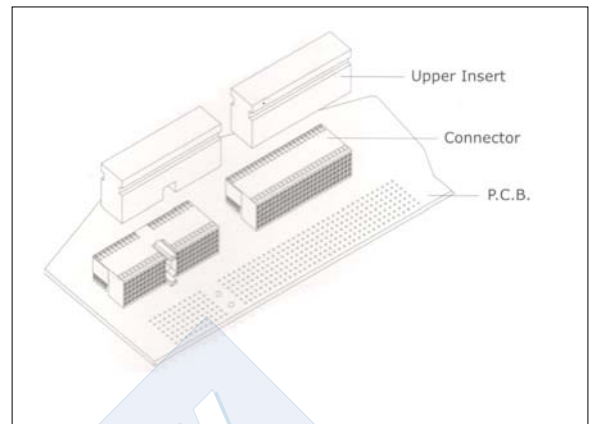

CONNECTORS SERIES	
FEMALE	MALE
A000	A001
AB50	AB51
AB20	AB21
AB90	AB91
B250	B251
B220	B221
B190	B191
C000	C001
L000	L001
M000	M001
N000	N001

(PL) *Pin Length Options:

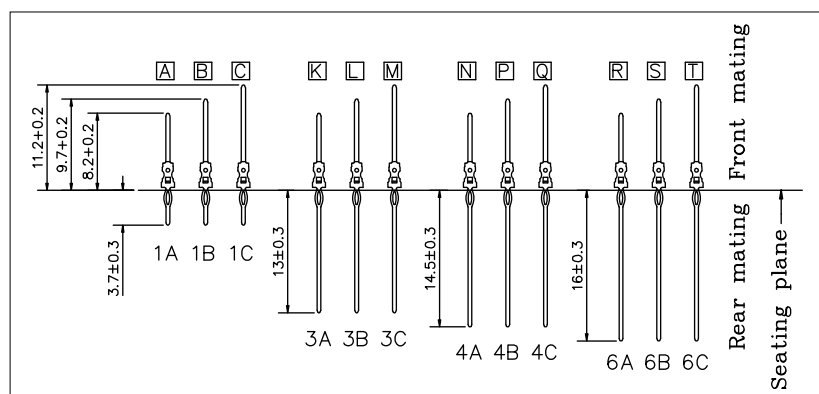

2.00 mm. HARD METRIC CONNECTORS



Ordering and part numbers.

Overview

Apfel 2.0mm HARD METRIC CONNECTOR MODULES comply with international IEC 917 and IEC 61076-4-101 standards. The connector system is designed and manufactured to meet the emerging trend of higher density and faster signal transmission in the electronic industries and ideal for application in the telecommunication, industrial PC.

All products are ROHS compliant

Type A Connectors	Type AB Connectors	Type B Connectors
Type C Connectors	Type L Connectors	Type M Connectors
Type N Connectors	Shrouds	Coding keys & Shielding Covers

2.00 mm. HARD METRIC CONNECTORS



Ordering and part numbers.

Fill in diagram below with designated contact types required. Unfilled positions to be left blank.

Type A Connector

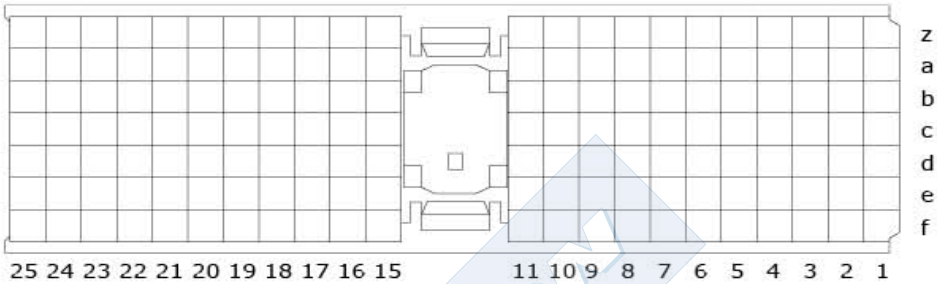

Type AB25 Connector

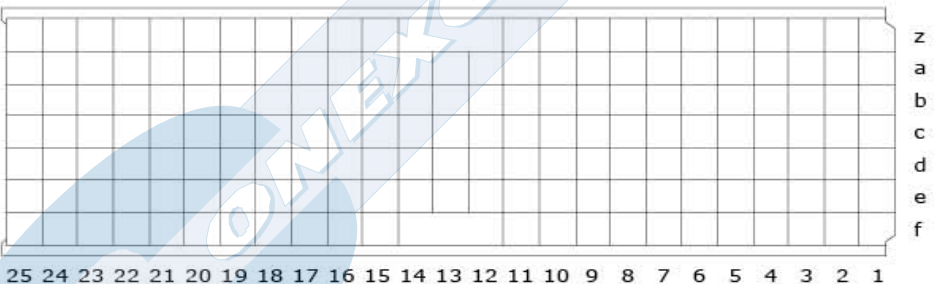

Type AB22 Connector

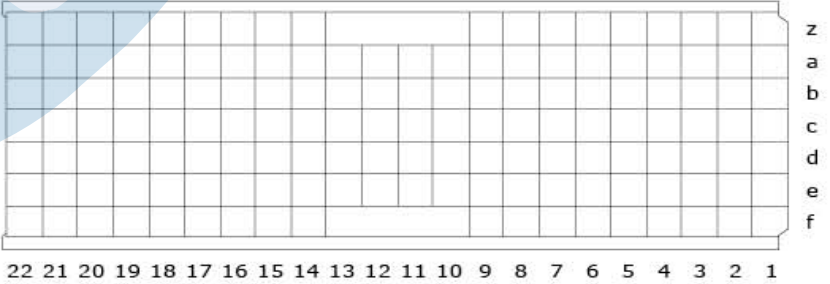

Type AB19 Connector

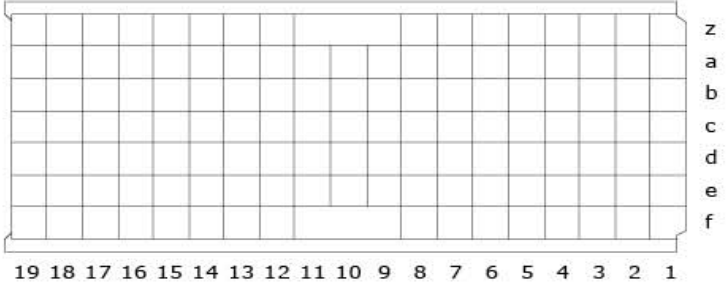

2.00 mm. HARD METRIC CONNECTORS



Ordering and part numbers.

Type B25 Connector

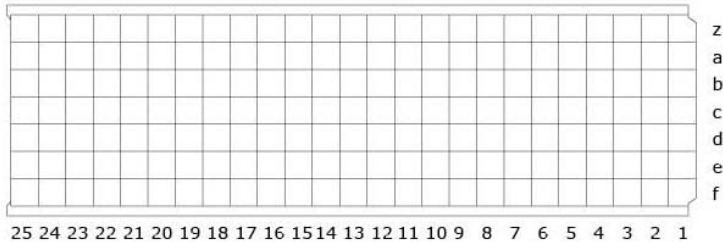

Type B22 Connector

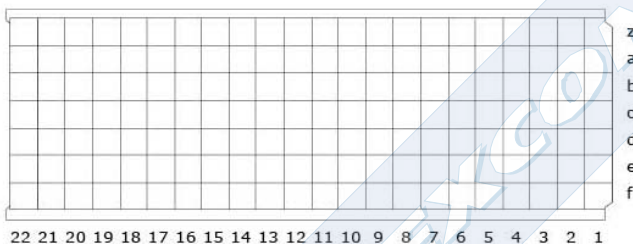

Type B19 Connector

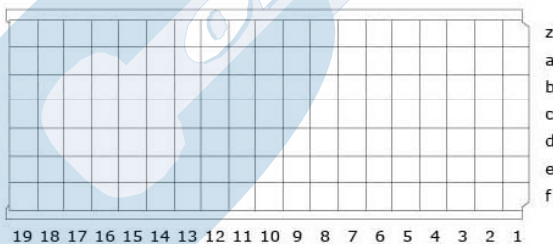

Type C Connector

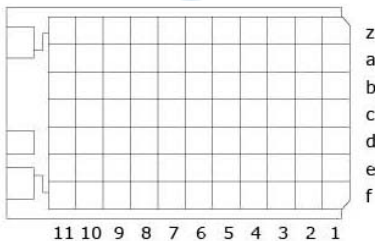

Type L Connector

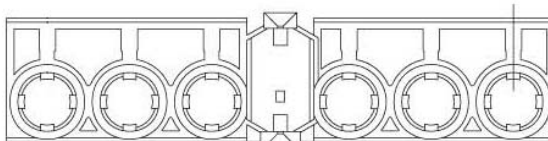

Type M Connector

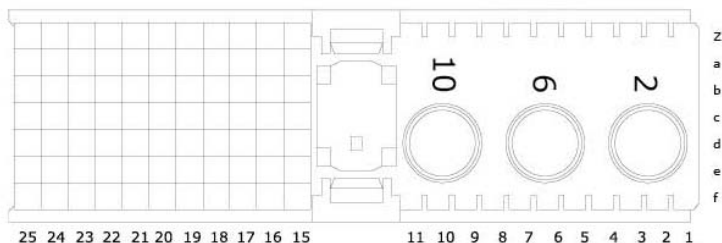

Type N Connector

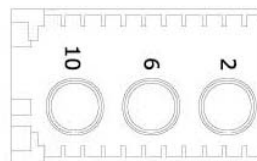

2.00 mm. HARD METRIC CONNECTORS



B250 SERIES. Right Angle Female Type B25 Connectors for Free Boards .

Product Information:

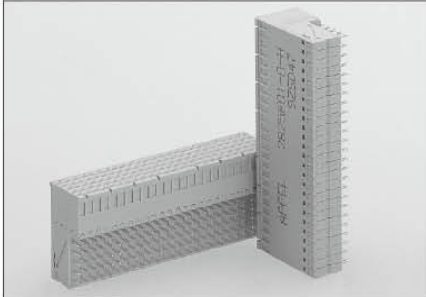

Right angle female type B25 connector provides 125 signal contacts in a 5 row X 25 position fully loaded configuration. Optional pre-assembled upper ground return shield is also provided or can be ordered separately. The lower ground return shield can be ordered separately.

Dimensions

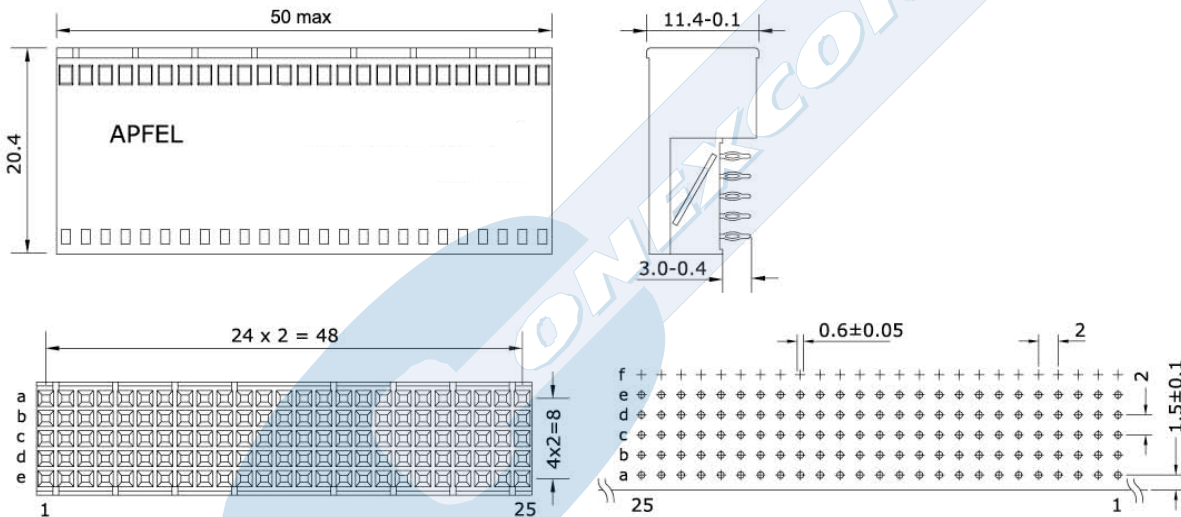

Dimensions shown are for reference purpose only. All dimensions are in millimeters unless otherwise specified.

Ordering Information:

B250- T- 125- 0- S
 1 2 3 4 5

1. Connector Series

2. (T) Contact Plating

- T = 3. Class 3. Gold flash plating
- T = 4. Class 2. 12 μ Pd/Ni + 2 μ Au (Recommended)
- T = 5. Class 1. 25 μ Pd/Ni + 2 μ Au

5. (S) Shielding

- 0. Not shielding
- 1. Shielding (Row Z and F)

2.00 mm. HARD METRIC CONNECTORS



B251 SERIES. Vertical Male Type B25 Connectors for Fix Boards.

Product Information:

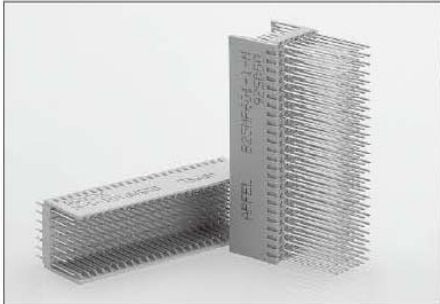

Type B25 vertical male connector provides 125 signal contacts and optional 50 shielding contacts respectively in 5 + 2 row X 25 position configuration. All are end to end stackable without change in contact pitch.

Dimensions

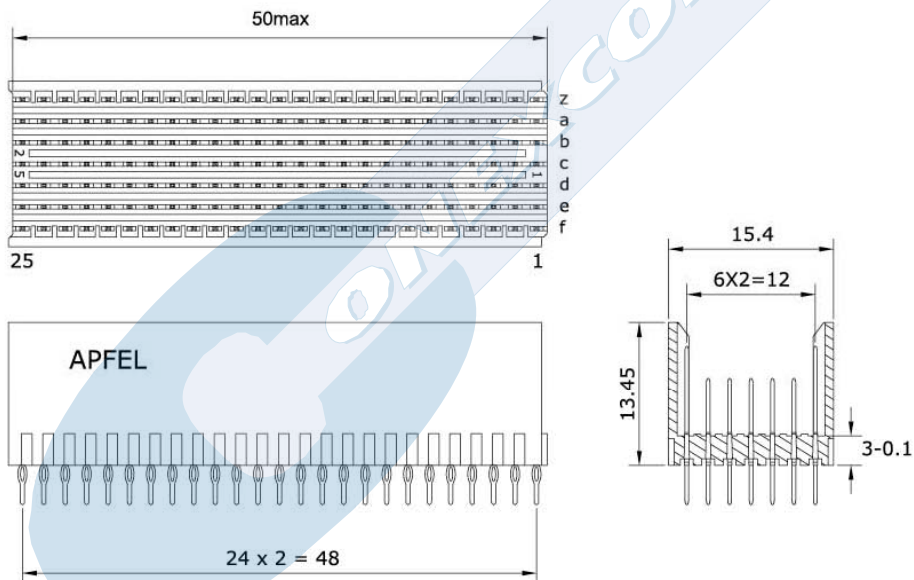

Recommended PCB Layout

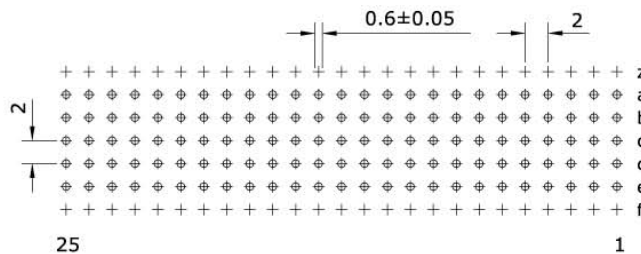

Dimensions shown are for reference purpose only. All dimensions are in millimeters unless otherwise specified.

2.00 mm. HARD METRIC CONNECTORS



B251 SERIES. Vertical Male Type B25 Connectors for Fix Boards.

Product Information:

Assembly Drawing	Total Number	Row	Type	Part Numbers
	125	z a b c d e f	- 1A 1A 1A 1A 1A -	B251-T*125001A00
	125	z a b c d e f	- 1B 1B 1B 1B 1B -	B251-T*125001B00
	175	z a b c d e f	1C 1A 1A 1A 1A 1A 1C	B251-T*175001A01
	175	z a b c d e f	1C 1B 1B 1B 1B 1B 1C	B251-T*175001B01

(T*) Contact Plating

- T = 3. Class 3. Gold flash plating
- T = 4. Class 2. 12 μ Pd/Ni + 2 μ Au (Recommended)
- T = 5. Class 1. 25 μ Pd/Ni + 2 μ Au

Male Contact Options

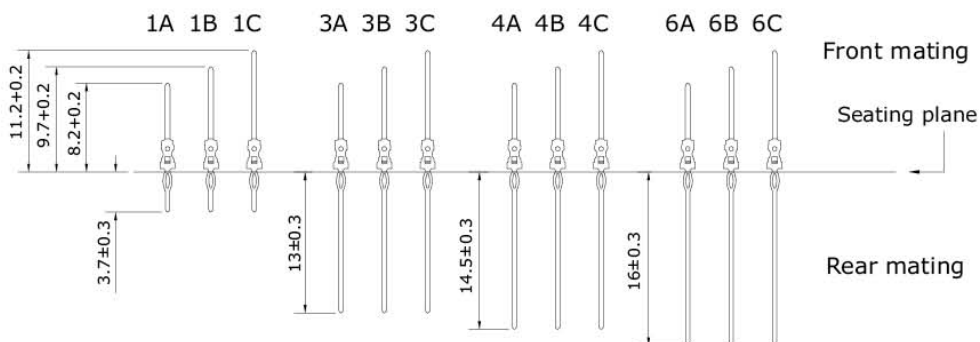

Dimensions shown are for reference purpose only. All dimensions are in millimeters unless otherwise specified.

2.00 mm. HARD METRIC CONNECTORS



B220 SERIES. Right Angle Female Type B22 Connectors for Free Boards.

Product Information:

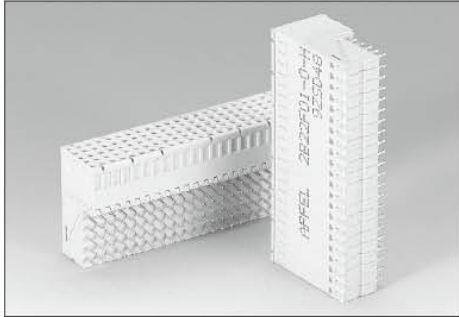

Right angle female type B22 connector provides 110 signal contacts in a 5 row X 22 position fully loaded configuration. Optional pre-assembled upper ground return shield is also provided or can be ordered separately. The lower ground return shield can be ordered separately. The 22 position one is used in the J2 and J5 location of the Compact PCI daughter card.

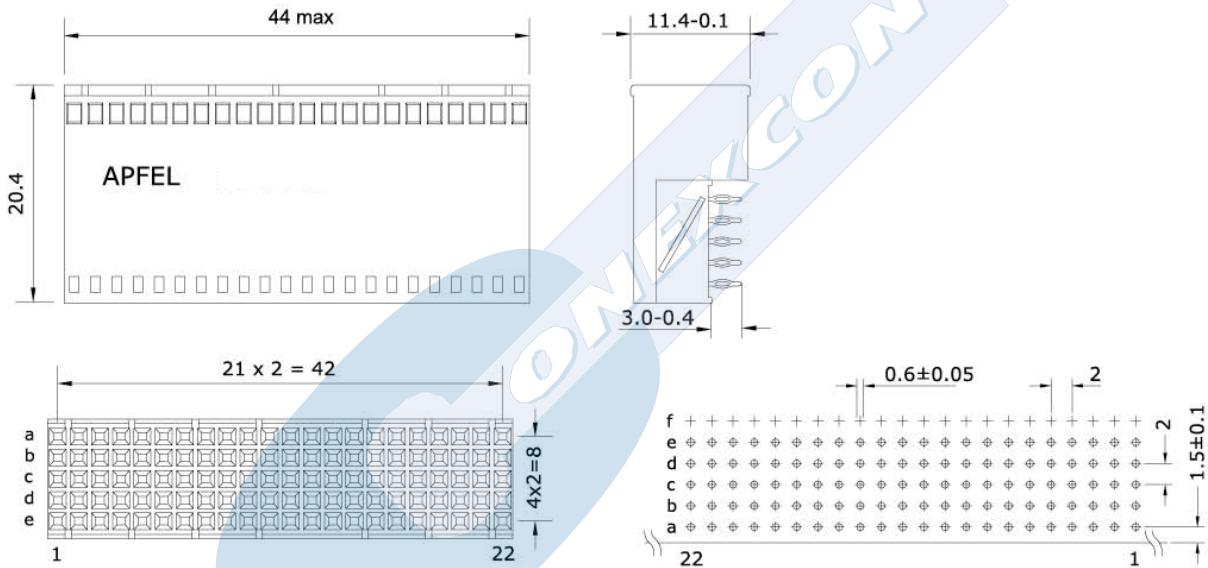

Dimensions shown are for reference purpose only. All dimensions are in millimeters unless otherwise specified.

Ordering Information:

B220- T- 110- 0- S
 1 2 3 4 5

1. Connector Series

2. (T) Contact Plating

- T = 3. Class 3. Gold flash plating
- T = 4. Class 2. 12 μ Pd/Ni + 2 μ Au (Recommended)
- T = 5. Class 1. 25 μ Pd/Ni + 2 μ Au

5. (S) Shielding

- 0. Not shielding
- 1. Shielding (Row Z and F)

2.00 mm. HARD METRIC CONNECTORS



B221 SERIES. Vertical Male Type B22 Connectors for Fix Boards.

Product Information:

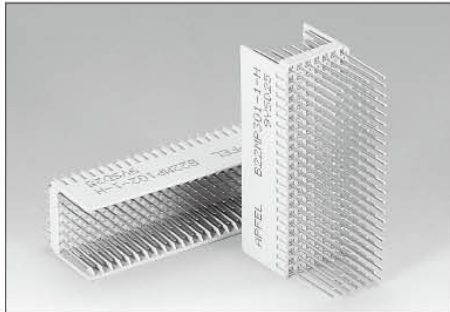

Type B22 vertical male connector provides 110 signal contacts and optional 44 shielding contacts respectively in 5 + 2 row X 22 position configuration. All are end to end stackable without change in contact pitch.

Dimensions

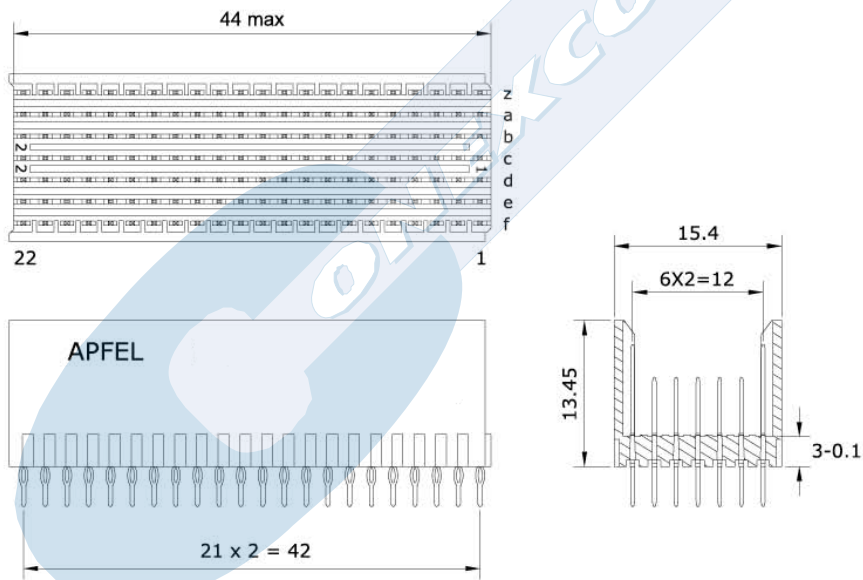

Recommended PCB Layout

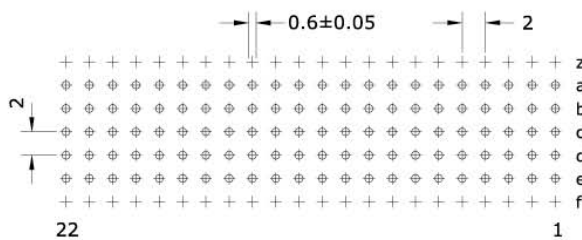

Dimensions shown are for reference purpose only. All dimensions are in millimeters unless otherwise specified.

2.00 mm. HARD METRIC CONNECTORS



B221 SERIES. Vertical Male Type B22 Connectors for Fix Boards.

Product Information:

Assembly Drawing	Total Number	Row	Type	Part Numbers
	110	z a b c d e f	- 1A 1A 1A 1A 1A -	B221-T*110001A00
	110	z a b c d e f	- 1B 1B 1B 1B 1B -	B221-T*110001B00
	154	z a b c d e f	1C 1A 1A 1A 1A 1A 1C	B221-T*154001A01
	154	z a b c d e f	1C 1B 1B 1B 1B 1B 1C	B221-T*154001B01
<p>cPCI Telephony Spec</p>	154	z a b c d e f	1C 1A/1B 1A/1B 1A/1B 1A/1B 1A/1B 1C	B221-T*154011A01

(T*) Contact Plating

- T = 3. Class 3. Gold flash plating
- T = 4. Class 2. 12 μ Pd/Ni + 2 μ Au (Recommended)
- T = 5. Class 1. 25 μ Pd/Ni + 2 μ Au

2.00 mm. HARD METRIC CONNECTORS



B190 SERIES. Right Angle Female Type B19 Connectors for Free Boards .

Product Information:

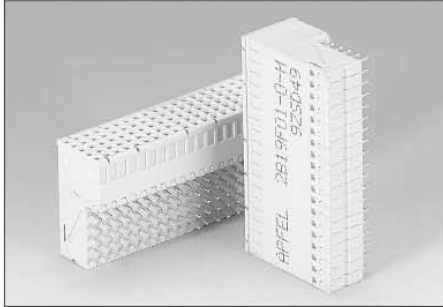

Right angle female type B19 connector provides 95 signal contacts in a 5 row X 19 position fully loaded configuration. Optional pre-assembled upper ground return shield is also provided or can be ordered separately. The lower ground return shield can be ordered separately. The 19 position one is used in the J3 location of the compact PCI daughter card.

Dimensions

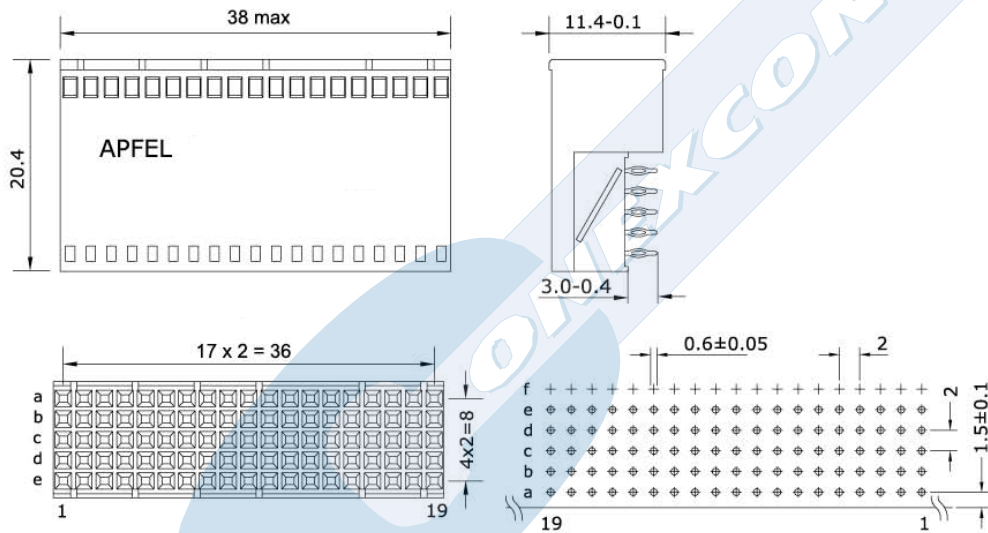

Dimensions shown are for reference purpose only. All dimensions are in millimeters unless otherwise specified.

Ordering Information:

B190- T- 095- 0- S

1 2 3 4 5

1. Connector Series

2. (T) Contact Plating

- T = 3. Class 3. Gold flash plating
- T = 4. Class 2. 12 μ Pd/Ni + 2 μ Au (Recommended)
- T = 5. Class 1. 25 μ Pd/Ni + 2 μ Au

5. (S) Shielding

- 0. Not shielding
- 1. Shielding (Row Z and F)

2.00 mm. HARD METRIC CONNECTORS



B191 SERIES. Vertical Male Type B19 Connectors for Fix Boards.

Product Information:

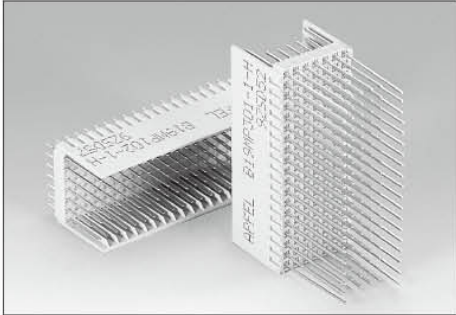

Type B19 vertical male connector provides 95 signal contacts and optional 38 shielding contacts respectively in 5 + 2 row X 19 position configuration. All are end to end stackable without change in contact pitch.

Dimensions

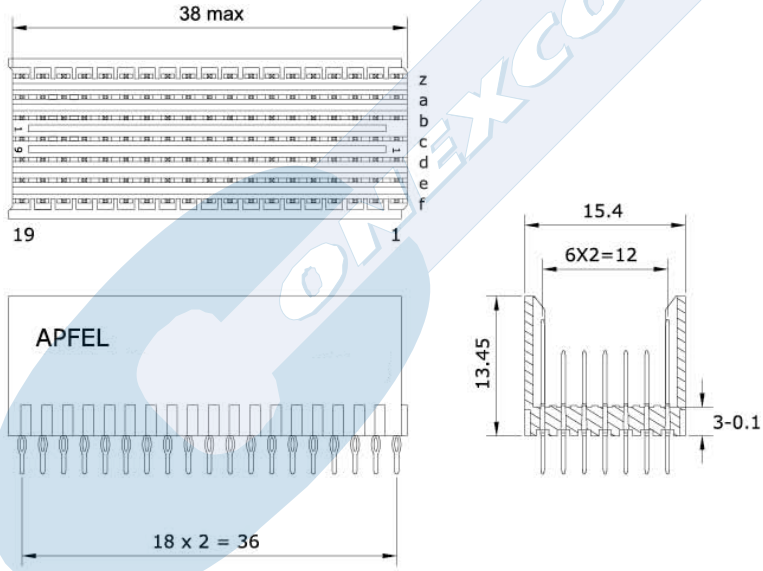

Recommended PCB Layout

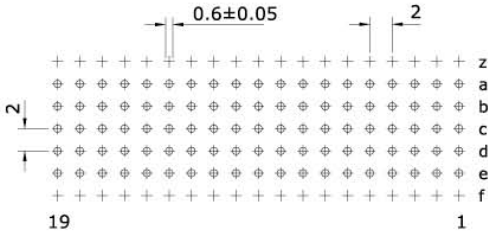

Dimensions shown are for reference purpose only. All dimensions are in millimeters unless otherwise specified.

2.00 mm. HARD METRIC CONNECTORS



B191 SERIES. Vertical Male Type B22 Connectors for Fix Boards.

Product Information:

Assembly Drawing	Total Number	Row	Type	Part Numbers
<p>cPCI Telephony Spec</p>	95	z a b c d e f	- 1A 1A 1A 1A 1A -	B191-T*095001A00
	95	z a b c d e f	- 1B 1B 1B 1B 1B -	B191-T*095001B00
	133	z a b c d e f	1C 1A 1A 1A 1A 1A 1C	B191-T*133001A01
	133	z a b c d e f	1C 1B 1B 1B 1B 1B 1C	B191-T*133001B01

(T*) Contact Plating

- T = 3. Class 3. Gold flash plating
- T = 4. Class 2. 12 μ Pd/Ni + 2 μ Au (Recommended)
- T = 5. Class 1. 25 μ Pd/Ni + 2 μ Au

Male Contact Options

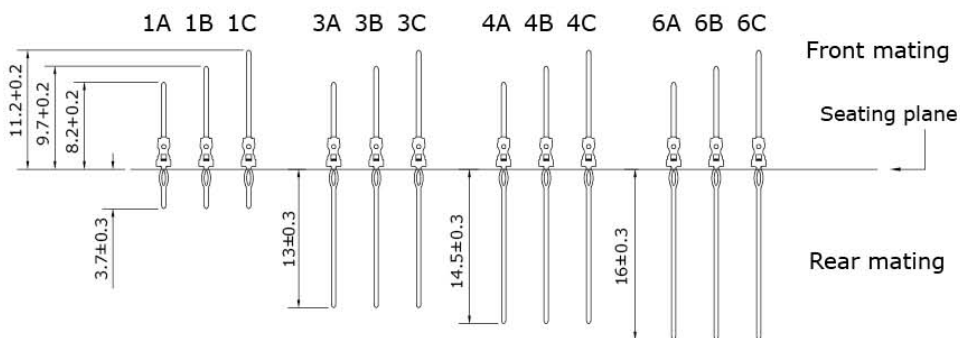

Dimensions shown are for reference purpose only. All dimensions are in millimeters unless otherwise specified.