

SIDE ENTRY PCB JACK FCC-68



7657 SERIES. Shielded / Unshielded available.

General Features

- Available 8/8 and 10/10 circuits
- Standard telephone jack FCC-68
- 13.46 mm height. Low depth 15.75 mm
- Accept standard plugs FCC-68
- Selective gold plating with different plating
- Bifurcated plastic foot print
- With/without grounding tabs

Materials

- Insulator: Thermoplastic UL 94V-0
- Contact: 0.35 mm thickness phosphor bronze
- Shielded: 0.25 mm thickness brass
- Operating temperature. -25°C to + 85°C
- RoHS compliant

Dimensional Information

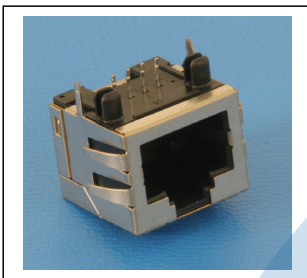

Electrical Features

- Voltage rating: < 125 V
- Current rating: < 1.50 A
- Contact resistance: < 20 mΩ
- Dielectric Withstanding Voltage: 300 V AC/minute
- Insulation Resistance: >1000 MΩ

mechanical Features

- Durability: 1000 cycles

Circuits	Part Number		
	Unshielded	Shielded	
	-	W/O Groundig Tab	With Groundig Tab
8/8	7657 - T880	7657 - T881	7657 - T882
10/10	7657 - T100	7657 - T101	7657 - T102

T = Plating Options

- T = 4. 6μ" gold over nickel
- T = 5. 15μ" gold over nickel
- T = 6. 30μ" gold over nickel
- T = 7. 50μ" gold over nickel

Shielded Version

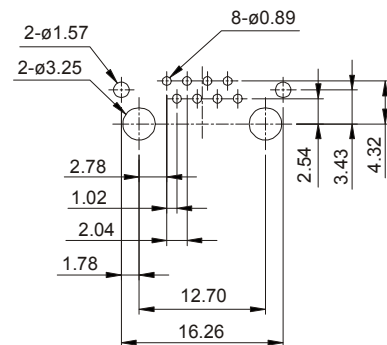
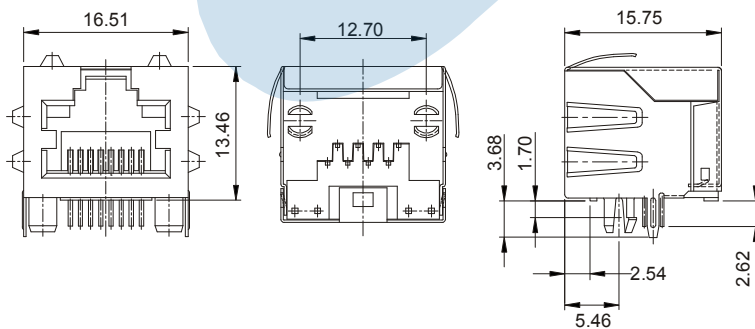

Unshielded Version

