

CRIMP MALE TERMINAL



6201 SERIES. 6.20 mm. (0.244 ") Pitch housing

General Features

- Accommodates wire range AWG 14 through 20
- Use in housing 6.20 mm pitch 6200 series
- Male contact tin plated with locking lance
- Maximum insulation diameter 4.10 mm (0.161")

Materials

- Contact: Tin pre plated Brass
- Operating temperature -40°C to +105°C

Dimensional Information

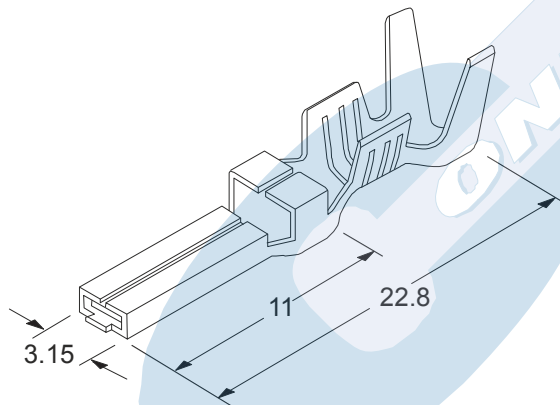

Electrical Features

- Current rating: < 20 A
- Contact resistance: < 7 mΩ

Mechanical Features

- Durability: 25 cycles
- Wire pull-out force:
 - 12.00 Kgf 14 AWG
 - 11.00 Kgf 16 AWG
 - 9.00 Kgf 18 AWG
 - 7.00 Kgf 20 AWG

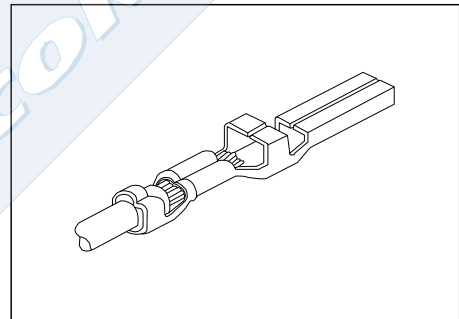

6201 - T- 00- E

1

2

1. Terminal Serie

2. (T) Contact Plating

- T = 2. Tin plated

2. (E) Packing Options

- E = 0. Chain
- E = 1. Loose Piece